



P R O S T H E T I C S



NEW!

Trulife Lower Limb Systems



BEST VALUE | TESTED | TRUSTED | PREFERRED



Jay Humphries is Trulife's very own engineer who is at the cutting edge of product development in prosthetics. He's also a war veteran, a double amputee and an experienced sky diver, and he personally tests new products.

Zenith and Zenith LP Lower Limb System ^{K3/K4}

- Highly dynamic and functional system that delivers incomparable performance
- Zenith foot features four resistance options at heel strike for patient fine-tuning
- Sandal-toe foot shell and Spectra sock included with foot
- Zenith is featured on page 12

Indications: Medium to high impact levels, K3-K4

Component List

ID	BELOW KNEE	ID	ABOVE KNEE
A	AAASMP	A	AAASMP
B	AAA210	B	AAA212
C	AAA225	C	AAA214-01 (SSK615)
D	AAA200 or AAA135	Ka	SSK615 or
		Kb	SSK615-THR
F	SZN20x/SZN10x	D	AAA200
		F	SZN20x/10x

Weight Limit

BELOW KNEE	ABOVE KNEE
136 kg / 300 lb	100 kg / 220 lb (SSK615)
	125 kg / 275 lb (SSK615-THR)



Triumph Lower Limb System ^{K3/K4}

- A dynamic and highly compliant system that offers multi-axial rotation and shock absorption
- Triumph foot features an integrated composite keel and shank for stability
- Solid toe foot shell and Spectra sock included with foot
- Triumph is featured on page 13

Indications: Medium to high impact levels, K3-K4

Component List

ID	BELOW KNEE	ID	ABOVE KNEE
A	AAASMP	A	AAASMP
B	AAA210	B	AAA212
C	AAA225	C	AAA214-01 (SSK615)
D	AAA200 or AAA135	Ka	SSK615 or
		Kb	SSK615-THR
F	STF190/193	D	AAA200
		F	STF190/193

Weight Limit

BELOW KNEE	ABOVE KNEE
160 kg / 350 lb	100 kg / 220 lb (SSK615)
	125 kg / 275 lb (SSK615-THR)

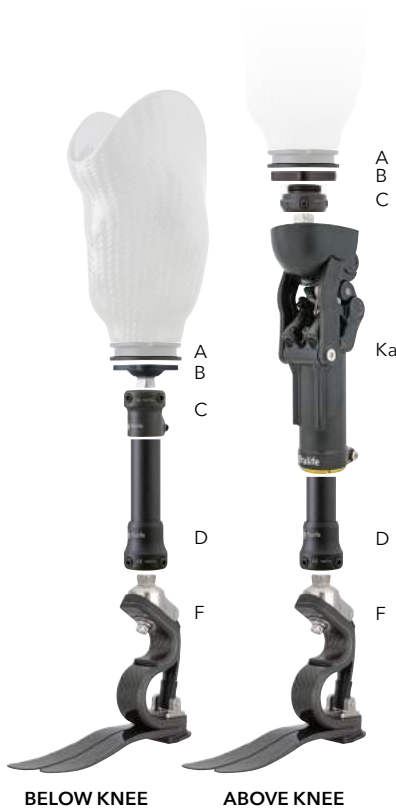

Child's Play Energy Lower Limb System ^{K3/K4}

- Composite keel with dynamic toe and cushioned heel response
- Lightweight, 4-bar, polycentric knee design
- Available in above knee and below knee configurations
- Child's Play Energy is featured on page 34

Indications: Medium to high impact levels, K3-K4

Component List

ID	BELOW KNEE	ID	ABOVE KNEE
A	AAAKSMP	A	AAAKSMP
B	AAAK210	B	AAAK211
C	AAAK100	K	SSK610A
D	AAAK135	D	AAAK135
E	AAAK285	E	AAAK285
	SFS24x (optional)		SFS24x (optional)
F	SEF132/144	F	SEF132/144

Weight Limit

BELOW KNEE	ABOVE KNEE
65 kg / 144 lb	55 kg / 121 lb

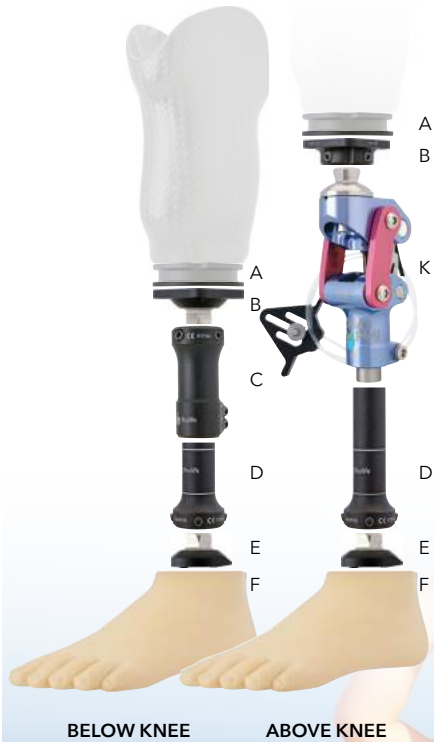

The System That Grows with Them!

- Build height adjusts from 92-220 mm (3.2-8.7 in)

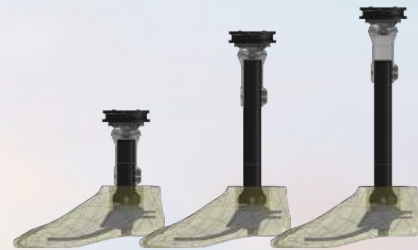

Zumo 450 Lower Limb System ^{K3}

- Heavy-duty BK system that withstands up to 450 lb
- Zumo foot features a split composite keel for increased stability
- Male pyramid, sandal-toe foot shell and Spectra sock included with foot
- Zumo450 is featured on page 15

Indications: Medium impact level, K3

Component List

ID	BELOW KNEE
A	AAASMP
B	AAAHTi210
C	AAAHTi225
D	AAAHTi200
F	SZM450/453

Weight Limit

205 kg / 450 lb



BELOW KNEE

Energy Lower Limb System ^{K3}

- An energetic system due to a dynamic toe and cushioned heel response
- Energy foot features a full length, split, composite keel for stability
- Male pyramid, sandal-toe foot shell and Spectra sock included with foot
- Energy is featured on page 14

Indications: Medium impact level, K3

Component List

ID	BELOW KNEE	ID	ABOVE KNEE
A	AAASMP	A	AAASMP
B	AAA210	B	AAA212
C	AAA225	C	AAA214-01 (SSK615)
D	AAA200 or AAA135	Ka	SSK615 or SSK615-THR
F	SEF190/193	D	AAA200
		F	SEF190/193

Weight Limit

BELOW KNEE	ABOVE KNEE
136 kg / 300 lb	100 kg / 220 lb (SSK615)
	125 kg / 275 lb (SSK615-THR)

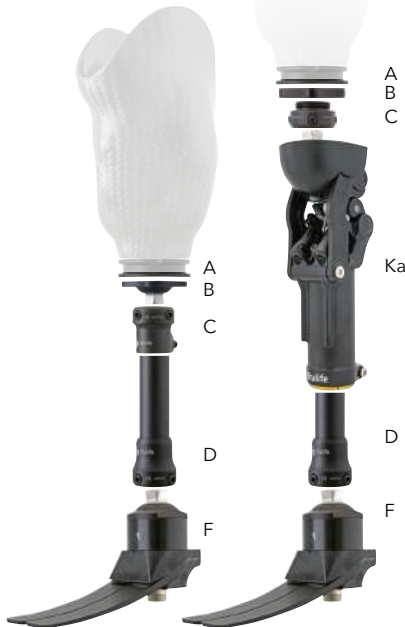

BELOW KNEE

ABOVE KNEE



Kb

Lightfoot² Lower Limb System ^{K3}

- Proven, established system for the medium activity level patient
- Lightfoot² features a dynamic composite keel with cushioned heel response
- Male pyramid and sandal-toe foot shell included with foot
- Lightfoot² is featured on page 17

Indications: Medium impact level, K3

Component List

ID	BELOW KNEE	ID	ABOVE KNEE
A	AAASMP	A	AAASMP
B	AAA210	B	AAA212
C	AAA225	C	AAA214-01 (SSK615)
D	AAA200 or AAA135	Ka	SSK615 or Kb SSK615-THR
F	SLF195/198	D	AAA200
		F	SLF195/198

Weight Limit

BELOW KNEE	ABOVE KNEE
136 kg / 300 lb	100 kg / 220 lb (SSK615)
	125 kg / 275 lb (SSK615-THR)

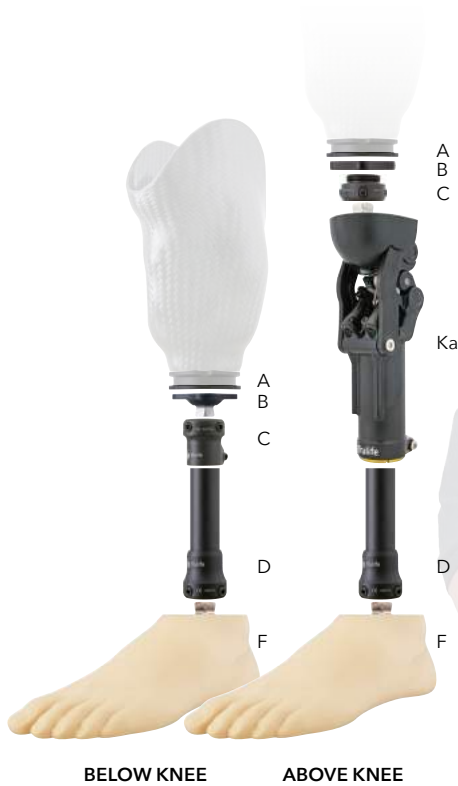

Kinetic Light Lower Limb System ^{K2}

- Flexible and highly functional system
- Kinetic Light foot features a flexible composite keel integrated with a multi-axial ankle
- Male pyramid and pylon included with foot
- Kinetic Light is featured on page 19

Indications: Low to medium impact levels, K2

Component List

ID	BELOW KNEE	ID	ABOVE KNEE
A	AAASMP	A	AAASMP
B	AAA210	B	AAA212
C	AAA225	C	AAA214-01
D	AAA200 (included with foot)	Ka	SSK617
F	SKF100/103	D	AAA200 (included with foot)
		F	SKF100/103

Weight Limit

BELOW KNEE	ABOVE KNEE
160 kg / 350 lb	100 kg / 220 lb

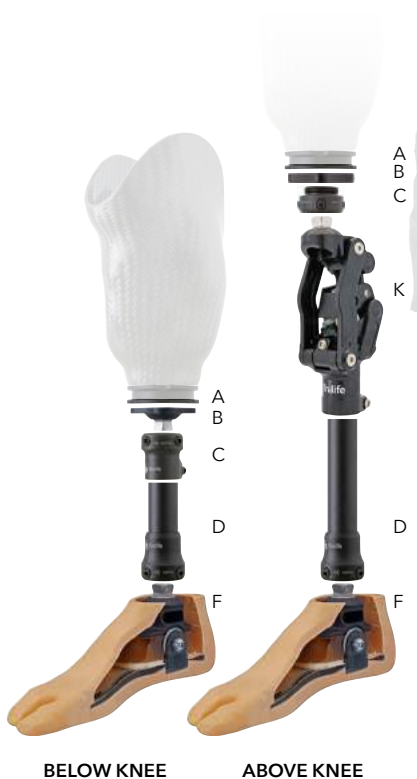

Edge Lower Limb System ^{K2}



- A system featuring an integrated multi-axial ankle for the K2 patient who is on the edge of advancing to a K3 activity level
- Edge foot has a low profile dynamic composite keel integrated with a multi-axial ankle
- Male pyramid and pylon included with foot
- Edge is featured on page 18

Indications: Medium impact level, K2

Component List

ID	BELOW KNEE	ID	ABOVE KNEE
A	AAASMP	A	AAASMP
B	AAA210	B	AAA212
C	AAA225	C	AAA214-01
D	AAA200 (included with foot)	K	SSK617
F	SKF300/SKF303	D	AAA200 (included with foot)
		F	SKF300/303

Weight Limit

BELOW KNEE	ABOVE KNEE
160 kg / 350 lb	100 kg / 220 lb



The system that gives your patient the EDGE!

- Low profile K2 foot with unique keel shape which promotes increased energy return and storage over other feet
- Includes dorsi-stop pad to stiffen toe response for the more active K2 ambulators
- Includes removable sandal-toe foot shell (light or dark)
- Male pyramid, bonded pylon included

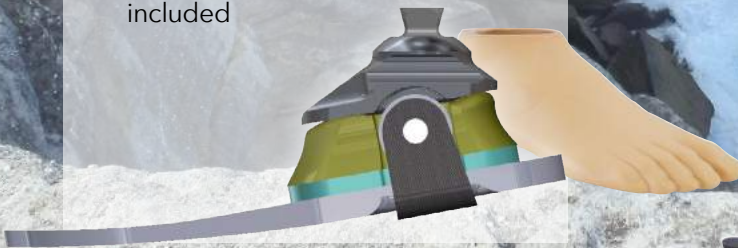

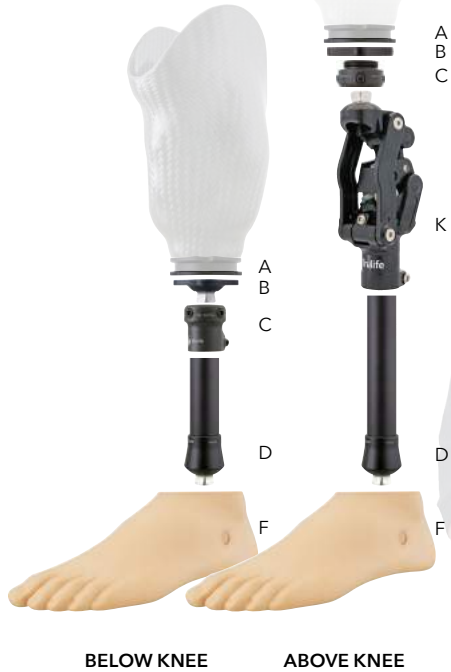

Kinetic Lower Limb System ^{K2}

- Flexible and highly functional system
- Kinetic foot features a flexible composite keel integrated with a multi-axial ankle
- Female pyramid and pylon included with foot
- Kinetic is featured on page 20

Indications: Low to medium impact levels, K2

Component List

ID	BELOW KNEE	ID	ABOVE KNEE
A	AAASMP	A	AAASMP
B	AAA210	B	AAA212
C	AAA225	C	AAA214-01
D	AAA202 (included with foot)	K	SSK617
F	SKF200/203	D	AAA202 (included with foot)
		F	SKF200/203

Weight Limit

BELOW KNEE	ABOVE KNEE
160 kg / 350 lb	100 kg / 220 lb



Natural Lower Limb System ^{K2}

- Lightweight and functional system that propels the amputee through cadence
- Natural foot is available in the natural looking Lightfoot Foot Shell or the detailed Lifecast Foot Shell
- Pyramid included with foot
- Natural is featured on page 21

Indications: Low to medium-low impact level, K2

Component List

ID	BELOW KNEE	ID	ABOVE KNEE
A	AAASMP	A	AAASMP
B	AAA210	B	AAA212
C	AAA225	C	AAA214-01
D	AAA200 or AAA135	K	SSK602L
F	SNF160/163 or SNF170/173	D	AAA200
		F	SNF160/163 or SNF170/173

Weight Limit

BELOW KNEE	ABOVE KNEE
102 kg / 225 lb	102 kg / 225 lb



SACH Lower Limb System ^{K1}

- Flexible and highly functional system for the new amputee
- SACH foot features a flexible composite keel integrated with a multi-axial ankle
- Pyramid included with foot
- SACH is featured on page 22

Indications: Low to medium-low impact level, K1

Component List

ID	BELOW KNEE	ID	ABOVE KNEE
A	AAASMP	A	AAASMP
B	AAA210	B	AAA212
C	AAA225	C	AAA214-01
D	AAA200 or AAA135	K	SSK602L
F	SCH110/113 or SCH120/123	D	AAA200
		F	SCH110/113 or SCH120/123

Weight Limit

BELOW KNEE	ABOVE KNEE
102 kg / 225 lb	102 kg / 225 lb

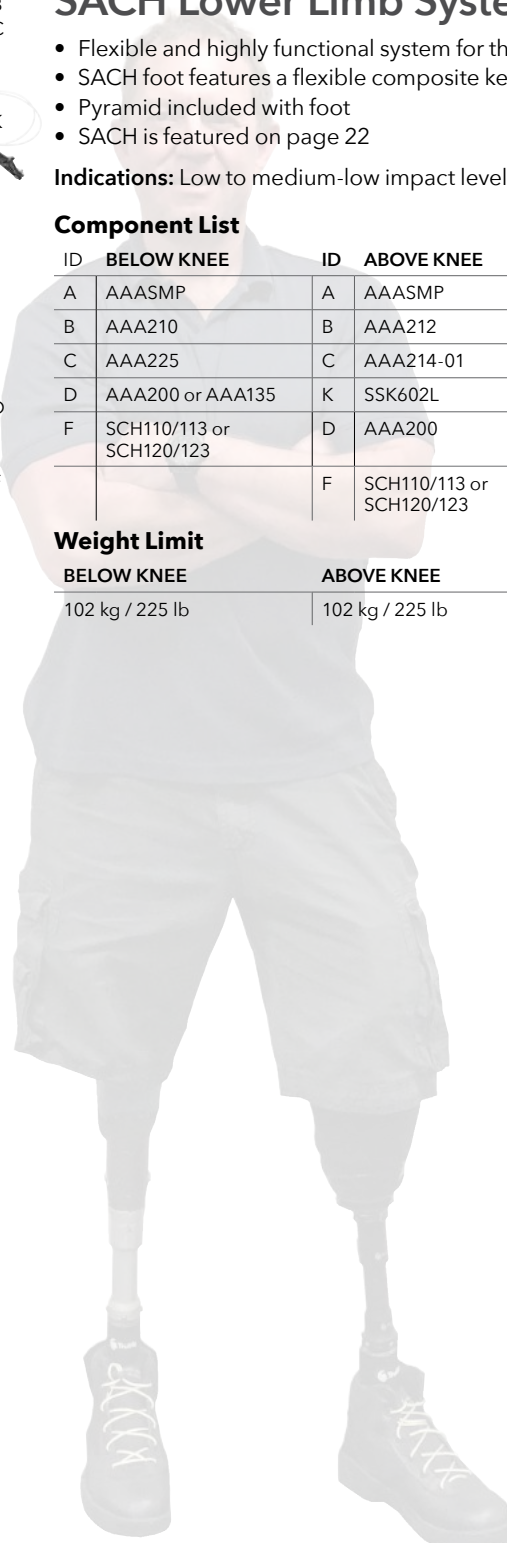



Contents

LOWER LIMB SYSTEMS

Zenith Lower Limb System ^{K3/K4}	3
Triumph Lower Limb System ^{K3/K4}	3
Child's Play Lower Limb System ^{K3/K4}	4
Zumo 450 Lower Limb System ^{K3}	5
Energy Lower Limb System ^{K3}	5
Lightfoot ² Lower Limb System ^{K3}	6
Kinetic Light Lower Limb System ^{K2}	6
Edge Lower Limb System ^{K2}	7
Kinetic Lower Limb System ^{K2}	8
Natural Lower Limb System ^{K2}	8
SACH Lower Limb System ^{K1}	9

FEET

Zenith and Zenith LP ^{K3/K4}	12
Triumph ^{K3/K4}	13
Zumo 450 ^{K3}	14
Energy ^{K3}	16
Lightfoot ² with Pyramid ^{K3}	17
Edge with Pylon ^{K3}	18
Kinetic Light with Pylon ^{K2}	19
Kinetic with Pylon ^{K2}	20
Natural with Pyramid ^{K1/K2}	21
SACH with Pyramid ^{K1}	22

KNEES

Select Stance Flexion Knee	24
Natural Stance Flexion Knee	25
PC Friction Control Knee with Lock	25

AAA MODULAR COMPONENTS

3-Prong Adapters	26
4-Hole Adapters	26
Clamp Adapters	26
Double-Ended Adapters	27
Foot Pyramid	27
Mounting Plate	27
Pylons	28
Heavy-Duty Titanium Adapters	28
AAA Do's and Don'ts	29

OTHER

Green Dot Valves	30
Below Knee Valve	30
Endoskeletal Cosmesis	31
Ankle Block	31
Symes Nut	32
AAA Mounting Plate	32

CHILD'S PLAY

Child's Play Energy ^{K3/K4}	34
Child's Play Knee with Manual Lock	35
Child's Play Adapters	36
Child's Play Endo/Exo Components	37

WARRANTY

Warranty	39
----------	----



Zenith and Zenith LP K3/K4

Revolutionary maintenance-free design delivering incomparable performance.

"Zenith is my favorite foot that I've EVER tried! It is far superior to any foot I've ever owned. Trulife knocked it out of the park with Zenith!"

– Pete McAfee

"My patient loved Zenith. He was getting perfect rollover, said his limb pain went down. He was able to run, walk fast. Really easy fitting."

– Bryan Roehr (Cornerstone P&O, Edmonds, WA)

"You always hear the phrase 'improved quality of life'. This foot has literally done that for me."

– Pete McAfee

NEW!

Maintenance-free design

Lightweight aerospace composite materials for increased comfort and reduced fatigue

Urethane bumper with four resistance options at heel strike for individual patient fine-tuning

Energetic, flexible toe loading response that automatically adjusts to variable walking speeds

Full-length sandal-toe ensures superior ground compliance to facilitate a well-balanced gait

Lightweight Z-pins to deliver increased structural integrity at keel/shank merge point



Pete McAfee

Professional FreeRide jet skier, avid downhill skier and hiker

See product specification on page 12

Contact your distributor today to place an order!

[f/trulifegroup](#) [in/company/trulife](#) [@TrulifeGroup](#)

www.trulife.com



Zenith and Zenith LP K3/K4

- Revolutionary design delivering incomparable performance
- Lightweight aerospace composite materials for comfort and reduced fatigue
- Integrated, lightweight 'Z' pins at forefoot for increased structural integrity
- Flexible toe loading response automatically adjusts to variable walking speeds
- Urethane bumper with four resistance options at heel strike for individual patient fine-tuning
- Full-length sandal toe for superior ground compliance and well-balanced gait

Indications: Medium to high impact levels, K3-K4

Selection

Model No.	Description	Size	Weight Limit
SZN200	Zenith, Light Foot Shell, 3/8" Heel Rise	22-30 cm	136 kg / 300 lb*
SZN203	Zenith, Dark Foot Shell, 3/8" Heel Rise	22-30 cm	136 kg / 300 lb*
SZN100	Zenith LP, Light Foot Shell, 3/8" Heel Rise	22-30 cm	136 kg / 300 lb*
SZN103	Zenith LP, Dark Foot Shell, 3/8" Heel Rise	22-30 cm	136 kg / 300 lb*
SKC300	Replacement Foot Shell, Light	22-30 cm	N/A
SKC303	Replacement Foot Shell, Dark	22-30 cm	N/A

Category Selection Instructions

The Trulife Zenith foot has three available category options. Each is designed and tested to support a specific weight and impact level combination. To optimize the selection and ensure amputee's safety, follow the two steps below to determine the appropriate category.

1. Locate the column that corresponds with the amputee's impact level.
2. Within the selected column, locate the amputee's weight.

Important Note: If the amputee has a long BK, carries heavy loads or will reach a higher impact level within a year, choose the next category higher.

Warning: Choosing a lower strength category than what is suggested based on the above procedure and patient data will void the warranty. If your patient's weight exceeds the limits of the chart please call Trulife Customer Service.

	Medium	Medium-High	High
Category	Walking on Uneven Surfaces	Light Sports	Running, Basketball
3	101-136 kg / 221-300 lb	88-118 kg / 193-260 lb	81-109 kg / 179-240 lb
2	81-100 kg / 177-220 lb	74-87 kg / 162-192 lb	68-80 kg / 150-176 lb
1	< 80 kg / < 176 lb	< 73 kg / < 161 lb	< 67 kg / < 149 lb



Specifications

Weight Limit	136 kg / 300 lb*
Product Sizes	22-30 cm
Toe	Sandal Toe
Foot Shell	Light, Dark
Product Weight Zenith: Zenith LP:	452 g / 1.00 lb 432 g / 0.95 lb (Size 27 without Foot Shell)
Min. Clearance Zenith: Zenith LP:	17.8 cm / 7.0 in 14.5 cm / 5.7 in
Heel Rise	9.5 mm / 3/8 in
Warranty Keel: Foot Shell:	3 years 6 months
Pre-assembled with	Foot Shell and Spectra Sock
Made in USA	

*For medium impact level, category 3



AAA200
Aluminum Pylon
Bonded to Female
Adapter (page 28)



Triumph K3/K4

- Narrow shank provides rotation and multi-axial compliance
- Optional toe wedges provide increased dorsiflexion resistance and proprioception
- Multi-axial rotation and shock absorption
- Full length, split, composite keel for stability on uneven surfaces
- Smooth rollover and controlled plantar flexion

Indications: Medium to high impact levels, K3-K4

Selection

Model No.	Description	Size	Weight Limit
STF190	Triumph, Light Foot Shell	22-30 cm	160 kg / 350 lb*
STF193	Triumph, Dark Foot Shell	22-30 cm	160 kg / 350 lb*
SFC290	Replacement Foot Shell, Light	22-30 cm	N/A
SFC293	Replacement Foot Shell, Dark	22-30 cm	N/A

Specifications

Weight Limit	160 kg / 350 lb*
Product Sizes	22-30 cm
Toe	Solid Toe
Foot Shell	Light, Dark
Product Weight	493 g / 1.09 lb (Size 25 without Foot Shell)
Min. Clearance	18 cm / 7.1 in
Heel Rise	9.5 mm / 3/8 in
Warranty Keel: Foot Shell:	3 years 6 months
Pre-assembled with	Foot Shell and Spectra Sock
Made in USA	

*For medium impact level, category 9

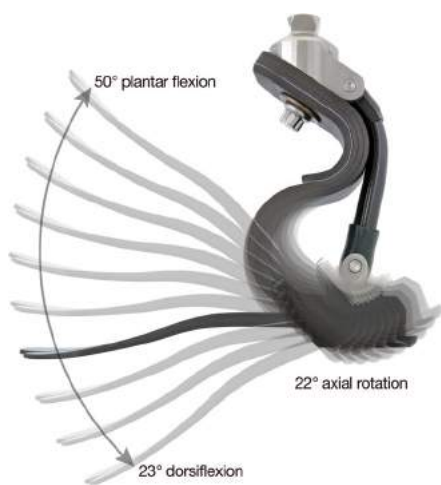

Category Selection Instructions

To optimize the selection and ensure amputee's safety, follow the two steps below to determine the appropriate category.

1. Locate the column that corresponds with the amputee's impact level.
2. Within the selected column, locate the amputee's weight.

Important Note: If the amputee has a long BK, carries heavy loads or will reach a higher impact level within a year, choose the next category higher.

Warning: Choosing a lower strength category than what is suggested based on the above procedure and patient data will void the warranty. If your patient's weight exceeds the limits of the chart please call Trulife Customer Service.

	Medium	Medium-High	High
Category	Walking Uneven Surfaces	Light Sports	Running, Basketball
9	141-160 kg / 310-350 lb	124-145 kg / 271-320 lb	106-125 kg / 232-274 lb
8	121-140 kg / 266-309 lb	106-123 kg / 232-270 lb	91-105 kg / 199-231 lb
7	101-120 kg / 221-265 lb	89-105 kg / 194-231 lb	76-90 kg / 166-198 lb
6	91-100 kg / 199-220 lb	80-88 kg / 175-193 lb	69-75 kg / 150-165 lb
5	81-90 kg / 177-198 lb	71-79 kg / 155-174 lb	61-68 kg / 133-149 lb
4	71-80 kg / 155-176 lb	62-70 kg / 136-154 lb	53-60 kg / 117-132 lb
3	66-70 kg / 144-154 lb	58-61 kg / 126-135 lb	50-53 kg / 108-116 lb
2	60-65 kg / 132-143 lb	53-57 kg / 117-125 lb	46-49 kg / 101-107 lb
1	< 60 kg / < 132 lb	< 53 kg / < 117 lb	< 46 kg / < 101 lb



AAA100
Adjustable Height
Clamp Adapter
(page 26)

AAA135
Variable Height
Adapter
(page 28)

AAA200
Aluminum Pylon
Bonded to Female
Adapter (page 28)



Zumo 450^{K3}

- Heavy-duty foot withstands up to 450 lb
- Durable composite design for K3 users
- Pre-assembled with a male pyramid for quick and easy installation
- Split composite keel for increased stability
- Dynamic toe and cushioned heel resposns
- Removable, life-like sandal-toe foot shell

Indications: Medium impact level, K3, maximum weight of 205 kg / 450 lb

Selection

Model No.	Description	Size	Weight Limit
SZM450	 Zumo, Light Foot Shell	22-30 cm	205 kg / 450 lb
SZM453	 Zumo, Dark Foot Shell	22-30 cm	205 kg / 450 lb
SFC190	 Replacement Foot Shell, Light	22-30 cm	N/A
SFC193	 Replacement Foot Shell, Dark	22-30 cm	N/A

Specifications

Weight Limit	205 kg / 450 lb
Product Sizes	22-30 cm
Toe	Sandal-Toe
Foot Shell	Light, Dark
Product Weight	750 g / 1.65 lb (Size 27 with Foot Shell)
Min. Clearance	10 cm / 4 in
Heel Rise	9.5 cm / 3/8 in
Warranty Keel: Foot Shell:	2 years 6 months
Includes	Foot Shell, Spectra Sock
Made in USA	



AAAHTi225
Heavy-Duty Adjustable
Height Clamp Adapter
(page 28)

AAAHTi200
Heavy-Duty Bonded
Pylon, 16 inch
(page 28)

Zumo 450 K3

NEW!

- Withstands up to 450 lb!
- Durable composite design for K3 users
- Pre-assembled with male pyramid for quick and easy installation
- Split composite keel for increased stability



AAAHDTi Adapters

- Lightweight Titanium
- Shot-peened to achieve a higher weight limit
- Six adapters available

AAASMP

- Mounting Plate



Contact your distributor today to place an order!



Specifications

Weight Limit	136 kg / 300 lb*
Product Sizes	22-30 cm
Toe	Sandal Toe
Foot Shell	Light, Dark
Product Weight	330 g / 0.73 lb (Size 25 without Foot Shell)
Min. Clearance	10 cm / 4 in
Heel Rise	9.5 mm / 3/8 in
Warranty Keel: Foot Shell:	2 years 6 months
Pre-assembled with	Foot Shell, Spectra Sock, Foot Bolt, 2.5 cm Foot Spacer and Foot Pyramid
Made in USA	

*For medium impact level, category 4

Energy^{K3}

- Dynamic toe and cushioned heel response
- Full length, split composite keel for increased stability
- Removable, life-like, sandal-toe foot shell
- Pre-assembled with male pyramid for easy installation
- Pyramid and spacer can be removed for Symes patient application

Indications: Medium impact level, K3

Selection

Model No.	Description	Size	Weight Limit
SEF190	Energy, Light Foot Shell	22-30 cm	136 kg / 300 lb*
SEF193	Energy, Dark Foot Shell	22-30 cm	136 kg / 300 lb*
SFC190	Replacement Foot Shell, Light	22-30 cm	N/A
SFC193	Replacement Foot Shell, Dark	22-30 cm	N/A

Category Selection Instructions

To optimize the selection and ensure amputee's safety, select the appropriate category based on the amputee's weight. Chart accommodates low-medium impact level amputees.

Important Note: If the amputee has a long BK, carries heavy loads or will reach a higher impact level within a year, choose the next category higher.

Warning: Choosing a lower strength category than what is suggested based on the above procedure and patient data will void the warranty. If your patient's weight exceeds the limits of the chart please browse the catalog for other foot options or call Trulife Customer Service.

	Low	Medium-Low	Medium
Category	Walking with Aid	Limited Walking	Walking Uneven Surfaces
4	101-136 kg 221-300 lb	101-136 kg 221-300 lb	101-136 kg 221-300 lb
3	81-100 kg 177-220 lb	81-100 kg 177-220 lb	81-100 kg 177-220 lb
2	61-80 kg 133-176 lb	61-80 kg 133-176 lb	61-80 kg 133-176 lb
1	< 60 kg < 132 lb	< 60 kg < 132 lb	< 60 kg < 132 lb



AAA100
Adjustable Height
Clamp Adapter
(page 26)

AAA135
Variable Height
Adapter
(page 28)

AAA200
Aluminum Pylon
Bonded to Female
Adapter (page 28)

Lightfoot² with Pyramid ^{K3}



- Arrives ready to install
- Natural looking, sandal toe foot shell (non-removable)
- Pre-assembled with a male pyramid for quick and easy installation
- Pyramid and spacer can be removed for Symes patient application

Indications: Medium impact level, K3

Selection

Model No.	Description	Size	Weight Limit
SLF195	 Lightfoot ² with Pyramid 9.5 mm / 3/8 in Heel, Light Foot Shell	22-30 cm	136 kg / 300 lb*
SLF198	 Lightfoot ² with Pyramid 9.5 mm / 3/8 in Heel, Dark Foot Shell	22-30 cm	136 kg / 300 lb*

Specifications

Weight Limit	136 kg / 300 lb*
Product Sizes	22-30 cm
Toe	Sandal Toe
Foot Shell	Light, Dark
Product Weight	480 g / 1.06 lb (Size 25)
Min. Clearance	9 cm / 3.5 in
Heel Rise	9.5 mm / 3/8 in
Warranty	
Keel:	2 years
Foot Shell:	1 year
Pre-assembled with	Foot Bolt, 2.5 cm Foot Spacer Foot Pyramid
Made in USA	

*For medium impact level

Category Selection Instructions

To optimize the selection and ensure amputee's safety, follow the two steps below to determine the appropriate keel.

1. Locate the column that corresponds with the amputee's impact level.
2. Within the selected column, locate the amputee's weight.

Important Note: If the amputee has a long BK, carries heavy loads or will reach a higher impact level within a year, choose the next category higher.

Warning: Choosing a lower strength category than what is suggested based on the above procedure and patient data will void the warranty. If your patient's weight exceeds the limits of the chart, please browse the catalog for other foot options or call Trulife Customer Service.

	Low	Medium-Low	Medium
Category	Walking with Aid	Limited Walking	Walking Uneven Surfaces
H9	-	116-136 kg 256-300 lb	114-136 kg 251-300 lb
H8	-	87-115 kg 191-255 lb	91-113 kg 201-250 lb
H7	123-136 kg 271-300 lb	75-86 kg 166-190 lb	69-90 kg 151-200 lb
H6	82-122 kg 181-270 lb	59-74 kg 131-165 lb	45-68 kg 101-150 lb
H5	< 82 kg < 181 lb	< 59 kg < 131 lb	< 45 kg < 101 lb



AAA100
Adjustable Height
Clamp Adapter
(page 26)

AAA135
Variable Height
Adapter
(page 28)

AAA200
Aluminum Pylon
Bonded to Female
Adapter (page 28)



Edge with Pylon ^{K2}

- All the benefits of the Kinetic Light with the addition of a removable, sandal toe foot shell and a more lively keel
- Low profile composite keel with multi-axial ankle
- Male pyramid attachment
- Ideal for patients on the edge of advancing to a K3 product

Indications: Medium impact level, K2

Selection

Model No.	Description	Size	Weight Limit
SKF300	 Edge, Light Foot Shell	22-30 cm	160 kg / 350 lb*
SKF303	 Edge, Dark Foot Shell	22-30 cm	160 kg / 350 lb*
SKC300	 Replacement Foot Shell, Light	22-30 cm	N/A
SKC303	 Replacement Foot Shell, Dark	22-30 cm	N/A

Specifications

Weight Limit	160 kg / 350 lb*
Product Sizes	22-30 cm
Toe	Sandal Toe
Foot Shell	Light, Dark
Product Weight	590 g / 1.30 lb (Size 27 without Pylon)
Min. Clearance	7 cm / 2.9 in
Heel Rise	9.5 mm / 3/8 in
Warranty Foot: Foot Shell:	2 years 6 months
Includes	Female Pylon (AAA200)
Made in USA	

*For category #5

Bumper Selection Instructions

To optimize selection, follow the three steps below to determine the appropriate category.

1. Locate the column associated with the amputee's foot length.
2. Locate the row corresponding to the amputee's weight.
3. The area where the column and row intersect lists the appropriate category.

Important Note: If the amputee has a long BK or carries heavy loads choose the next category higher.

Warning: Choosing a lower category than what is suggested based on the above procedure and patient data will void the warranty. If your patient's weight exceeds the limits of the chart, please browse the catalog for other foot options or call Trulife Customer Service.

Foot Length	22	23	24	25	26	27	28	29	30
Weight									
137-160 kg 301-350 lb	4	4	5	5	5	5	5	5	5
101-136 kg 221-300 lb	3	3	4	4	4	4	4	4	4
81-100 kg 177-220 lb	2	2	3	3	3	3	3	3	3
61-80 kg 133-176 lb	1	1	2	2	2	2	2	2	2
< 60 kg < 132 lb	1	1	1	1	1	1	1	1	1



AAA225
Clamp Adapter
(page 26)



AAA100
Adjustable Height
Clamp Adapter
(page 26)



Kinetic Light with Pylon ^{K2}

- K2 foot with integrated multi-axial ankle
- Proximal male pyramid
- Full length, composite keel
- Sandal toe foot shell (non-removable)
- Integrated ankle function for all categories is the same as the existing Kinetic

Indications: Low to medium impact level, K2

Selection

Model No.	Description	Size	Weight Limit
SKF100	 Kinetic Light, Light Foot Shell	22-30 cm	160 kg / 350 lb*
SKF103	 Kinetic Light, Dark Foot Shell	22-30 cm	160 kg / 350 lb*

Specifications

Weight Limit	160 kg / 350 lb*
Product Sizes	22-30 cm
Toe	Sandal Toe
Foot Shell	Light, Dark
Product Weight Cat 1-2: Cat 3-5:	481 g / 1.06 lb 564 g / 1.24 lb (Size 25 without Pylon)
Min. Clearance	7.3 cm / 2.9 in
Heel Rise	9.5 mm / 3.8 in
Warranty Foot: Foot Shell:	2 years 1 year
Includes	Female Pylon (AAA200)
Made in USA	

*For category #5

Bumper Selection Instructions

To optimize selection, follow the three steps below to determine the appropriate category.

1. Locate the column associated with the amputee's foot length.
2. Locate the row corresponding to the amputee's weight.
3. The area where the column and row intersect lists the appropriate category.

Important Note: If the amputee has a long BK or carries heavy loads choose the next category higher.

Warning: Choosing a lower category than what is suggested based on the above procedure and patient data will void the warranty. If your patient's weight exceeds the limits of the chart, please contact Trulife Customer Service.

Foot Length	22	23	24	25	26	27	28	29	30
Weight									
137-160 kg 301-350 lb	4	4	5	5	5	5	5	5	5
101-136 kg 221-300 lb	3	3	4	4	4	4	4	4	4
81-100 kg 177-220 lb	2	2	3	3	3	3	3	3	3
61-80 kg 133-176 lb	1	1	2	2	2	2	2	2	2
< 60 kg < 132 lb	1	1	1	1	1	1	1	1	1



AAA225
Clamp Adapter
(page 26)



AAA100
Adjustable Height
Clamp Adapter
(page 26)



Kinetic with Pylon ^{K2}

- K2 impact level
- Integrated multi-axial ankle
- Composite keel
- Sandal toe foot shell (non-removable)
- 43 cm / 17 inch male bonded pylon and female foot adapter included
- 160 kg / 350 lb* weight limit

Indications: Low to medium impact level, K2

Selection

Model No.	Description	Size	Weight Limit
SKF200	 Kinetic, Light Foot Shell	22-30 cm	160 kg / 350 lb*
SKF203	 Kinetic, Dark Foot Shell	22-30 cm	160 kg / 350 lb*

Specifications

Weight Limit	160 kg / 350 lb*
Product Sizes	22-30 cm
Toe	Sandal Toe
Foot Shell	Light, Dark
Product Weight	495 g / 1.09 lb (Size 25 without Pylon)
Min. Clearance	7 cm / 2.8 in
Heel Rise	9.5 mm / 3/8 in
Warranty Keel:	2 years
Foot Shell:	1 year
Includes	Male Bonded Pylon AAA202
Made in USA	

*For category #5

Bumper Selection Instructions

To optimize selection, follow the three steps below to determine the appropriate category.

1. Locate the column associated with the amputee's foot length.
2. Locate the row corresponding to the amputee's weight.
3. The area where the column and row intersect lists the appropriate category.

Important Note: If the amputee has a long BK or carries heavy loads choose the next category higher.

Warning: Choosing a lower category than what is suggested based on the above procedure and patient data will void the warranty. If your patient's weight exceeds the limits of the chart, please contact Trulife Customer Service.

Foot Length	22	23	24	25	26	27	28	29	30
Weight									
137-160 kg 301-350 lb	4	4	5	5	5	5	5	5	5
101-136 kg 221-300 lb	3	3	4	4	4	4	4	4	4
81-100 kg 177-220 lb	2	2	3	3	3	3	3	3	3
61-80 kg 133-176 lb	1	1	2	2	2	2	2	2	2
< 60 kg < 132 lb	1	1	1	1	1	1	1	1	1



AAA225
Clamp Adapter
(page 26)

AAA100
Adjustable Height
Clamp Adapter
(page 28)



Natural with Pyramid ^{K1/K2}



- Lightweight foot with Delrin keel
- Propels amputee through cadence
- Pre-assembled with a male pyramid for quick and easy installation
- Pyramid and spacer can be removed for Symes patient application
- Natural looking Lightfoot Foot Shell and realistically detailed Lifecast Foot Shell available in both light and dark (non-removable)

Indications: Low to medium-low impact levels, K1-K2; for single speed, home ambulators or new amputees

Specifications

Weight Limit	102 kg / 225 lb
Product Sizes	
Lightfoot Foot Shell:	22-30 cm
Lifecast Foot Shell:	22-29 cm
Toe	Sandal Toe
Foot Shell	Light, Dark
Product Weight	448 g / 0.98 lb (Size 25)
Min. Clearance	
SNF160, 163:	8.5 cm / 3.3 in
SNF170, 173	
(Size 22-26):	9 cm / 3.5 in
SNF170, 173	
(Size 27-29):	9.5 cm / 3.7 in
Heel Rise	
SNF160, 163:	9.5 mm / 3/8 in
SNF170, 173:	19 mm / 3/4 in
Warranty	
Keel:	2 years
Foot Shell:	1 year
Pre-assembled with	M10 Foot Bolt and Foot Pyramid
Made in USA	

Selection

Model No.	Description	Size	Weight Limit
SNF160	 Natural with Pyramid / 3/8 in Heel, Lightfoot Foot Shell, Light	22-30 cm	102 kg / 225 lb
SNF163	 Natural with Pyramid / 3/8 in Heel, Lightfoot Foot Shell, Dark	22-30 cm	102 kg / 225 lb
SNF170	 Natural with Pyramid / 3/4 in Heel, Lifecast Foot Shell, Light	22-29 cm	102 kg / 225 lb
SNF173	 Natural with Pyramid / 3/4 in Heel, Lifecast Foot Shell, Dark	22-29 cm	102 kg / 225 lb



Lightfoot Foot Shell, Light



Lightfoot Foot Shell, Dark



Lifecast Foot Shell, Light



Lifecast Foot Shell, Dark



AAA100
Adjustable Height
Clamp Adapter
(page 26)

AAA200
Aluminum Pylon
Bonded to Female
Adapter (page 28)



SACH with Pyramid ^{K1}

- Easy rollover
- Lightweight foot with Delrin keel
- Pre-assembled with a male pyramid for quick and easy installation
- Pyramid and spacer can be removed for Symes patient application
- Natural looking Lightfoot Foot Shell and realistically detailed Lifecast Foot Shell available in both light and dark (non-removable)

Indications: Low to medium-low impact level, K1

Selection

Model No.	Description	Size	Weight Limit
SCH110	 SACH with Pyramid / 3/8 in Heel, Lightfoot Foot Shell, Light	22-30 cm	102 kg / 225 lb
SCH113	 SACH with Pyramid / 3/8 in Heel, Lightfoot Foot Shell, Dark	22-30 cm	102 kg / 225 lb
SCH120	 SACH with Pyramid / 3/4 in Heel, Lifecast Foot Shell, Light	22-29 cm	102 kg / 225 lb
SCH123	 SACH with Pyramid / 3/4 in Heel, Lifecast Foot Shell, Dark	22-29 cm	102 kg / 225 lb

Specifications

Weight Limit	102 kg / 225 lb
Product Sizes Lightfoot Foot Shell: Lifecast Foot Shell:	22-30 cm 22-29 cm
Toe	Sandal Toe
Foot Shell	Light, Dark
Product Weight	549 g / 1.21 lb (Size 25)
Min. Clearance SCH110, 113: SCH120, 123 (Size 22-26): SCH120, 123 (Size 27-29):	8.5 cm / 3.3 in 9 cm / 3.5 in 9.5 cm / 3.7 in
Heel Rise SCH110, 113: SCH120, 123:	9.5 mm / 3/8 in 19 mm / 3/4 in
Warranty Keel: Foot Shell:	2 years 1 year
Pre-assembled with	M10 Foot Bolt and Foot Pyramid
Made in USA	



Lightfoot Foot Shell,
Light



Lightfoot Foot Shell,
Dark



Lifecast Foot Shell,
Light



Lifecast Foot Shell,
Dark



AAA100
Adjustable Height
Clamp Adapter
(page 26)

AAA200
Aluminum Pylon
Bonded to Female
Adapter (page 28)

Trulife Knees



SSK615 (page 23)

Ideal for use with these feet:

- Zenith (page 12)
- Zenith LP (page 12)
- Triumph (page 13)
- Energy (page 14)
- Lightfoot² (page 17)

SSK615-THR (page 23)

- Zenith (page 12)
- Zenith LP (page 12)
- Triumph (page 13)
- Energy (page 14)
- Lightfoot² (page 17)

SSK617 (page 24)

- Edge (page 18)
- Kinetic Light (page 19)
- Kinetic (page 20)

SSK602L (page 24)

- Natural (page 21)
- SACH (page 22)

SSK610A (page 35)

- Child's Play Energy (page 34)

Ask about our competitive pricing!

Contact your distributor today to place an order!



Select Stance Flexion Knee

- Polycentric, pneumatic 5-bar knee
- 9° of adjustable stance flexion
- Shock absorption at heel strike
- Independently adjustable pneumatic flexion and extension control
- Available with built-in proximal pyramid or threaded adapter
- Equipped with a built-in knee cap, preventing clothing from getting caught in the mechanism

Indications:

SSK615: Above knee amputation, medium to high impact level, K3-K4, maximum weight of 100 kg / 220 lb

SSK615-THR: Above knee amputation, medium to high impact level, K3-K4, maximum weight of 125 kg / 275 lb

Selection

Model No.	Description	Weight Limit
SSK615	Select Stance Flexion Knee with Proximal Pyramid	100 kg / 220 lb
SSK615-THR	Select Stance Flexion Knee with Threaded Proximal Adapter	125 kg / 275 lb

Specifications

SSK615	
Weight Limit	100 kg / 220 lb
Product Weight	1100 g / 2.42 lb
Overall Height	24 cm / 9.4 in
Distance to Knee Center	3 cm / 1.2 in
Flexion	145°
Warranty	2 years
SSK615-THR	
Weight Limit	125 kg / 275 lb
Product Weight	1100 g / 2.5 lb
Overall Height	23.2 cm / 9.1 in
Distance to Knee Center	2 cm / 0.8 in
Flexion	145°
Warranty	2 years



AAASS237
3-Prong Rotatable
Lamination Piece
(page 26)

AAA214-01
Rotatable Female
Insert
(page 26)

STF190, 193
Triumph
(page 13)

AAA135
Variable Height
Adapter
(page 28)



Natural Stance Flexion Knee

- 7° of adjustable stance flexion
- Friction swing phase control
- Shock absorption at heel strike
- Extension assist
- Built-in proximal pyramid and distal tube adapter

Indications: Above knee amputation, low to moderate impact level, K1-K2, maximum weight of 100 kg / 220 lb

Selection

Model No.	Description	Weight Limit
SSK617	Natural Stance Flexion Knee	100 kg / 220 lb

Specifications

Weight Limit	100 kg / 220 lb
Product Weight	783 g / 1.73 lb
Overall Height	18.5 cm / 7.3 in
Distance to Knee Center	3.2 cm / 1.3 in
Flexion	150°
Warranty	2 years



AAASS237
3-Prong Rotatable
Lamination Piece
(page 26)

AAA214-01
Rotatable Female
Insert
(page 26)

SKF200, 300
Kinetic with Pylon
(page 20)

AAA200
Aluminum Pylon
Bonded to Female
Adapter (page 28)

PC Friction Control Knee with Lock

- Polycentric, 4-bar friction control knee with manual lock
- A lightweight, durable knee that can be used in locked position or free motion
- Constant friction braking mechanisms and spring-loaded extension assist helps to create a natural gait
- Built-in proximal pyramid

Indications: Above knee amputation, low to moderate impact level, K1-K2, maximum weight of 136 kg / 300 lb

Selection

Model No.	Description	Weight Limit
SSK602L	PC Friction Control Knee with Lock	136 kg / 300 lb



Specifications

Weight Limit	136 kg / 300 lb
Product Weight	630 g / 1.39 lb
Overall Height	13.5 cm / 5.3 in
Distance to Knee Center	3.2 cm / 1.3 in
Flexion	145°
Warranty	2 years



AAASS237
3-Prong Rotatable
Lamination Piece
(page 26)

AAA214-01
Rotatable Female
Insert
(page 26)

SNF160, 163, 170, 173
Natural
with Pyramid
(page 21)

AAA 3-Prong Adapter



Model No.	Description	Rotatable	Connection	Material	Product Weight	Weight Limit
AAASS237	3-Prong Laminating Piece SS***	Yes	M36 Thread	Stainless Steel	107 g / 3.8 oz	136 kg / 300 lb

AAA 4-Hole Adapters



Model No.	Description	Material	Connection	Hole Inner Diameter	Product Weight	Weight Limit
AAA210	4-Hole Pyramid Adapter**	Aluminum	Male, Four-Hole	10 mm / 0.4 in	90 g / 3.2 oz	160 kg / 350 lb
AAA211	4-Hole Female Adapter*/**	Aluminum	Female, Four-Hole	N/A	88 g / 3.1 oz	160 kg / 350 lb
AAA212	4-Hole Rotatable Flange**/***	Aluminum	Four-Hole	N/A	58 g / 2.0 oz	160 kg / 350 lb
AAA214-01	Rotatable Female Insert*	Aluminum	Female, M36 Thread	N/A	67 g / 2.3 oz	160 kg / 350 lb
AAA216-01	Rotatable Male Pyramid Insert	Aluminum	Male, M36 Thread	10 mm / 0.4 in	54 g / 1.9 oz	160 kg / 350 lb
AAA208	4-Hole Double Offset Pyramid Adapter**	Aluminum	Male, Four-Hole	10 mm / 0.4 in	90 g / 3.2 oz	160 kg / 350 lb
AAA209	4-Hole Single Offset Pyramid Adapter**	Aluminum	Male, Four-Hole	10 mm / 0.4 in	90 g / 3.2 oz	160 kg / 350 lb



AAA Clamp Adapters



Model No.	Description	Dimensions	Material	Connection	Product Weight	Weight Limit
AAA100	Adjustable Height Clamp Adapter*/***	Height 75 mm / 3.0 in; 30 mm ID	Aluminum	Female	120 g / 4.2 oz	160 kg / 350 lb
AAA225	Clamp Adapter*/***	Height 48 mm / 1.9 in; 30 mm ID	Aluminum	Female	90 g / 3.2 oz	160 kg / 350 lb

Made in USA

*Includes set screws. **Includes mounting screws. ***Includes clamp screw.

AAA Double-Ended Adapters



Model No.	Description	Height	Material	Connection	Product Weight	Weight Limit
AAA221	Double-Ended Adapter*	35 mm / 1.375 in	Aluminum	Female	109 g / 3.8 oz	160 kg / 350 lb
AAA222	Double-Ended Adapter*	45 mm / 1.8 in	Aluminum	Female	125 g / 4.4 oz	160 kg / 350 lb
AAA223	Double-Ended Adapter*	60 mm / 2.4 in	Aluminum	Female	142 g / 5 oz	160 kg / 350 lb
AAA224	Double-Ended Adapter*	75 mm / 3 in	Aluminum	Female	158 g / 5.6 oz	160 kg / 350 lb

AAA Foot Pyramid



Model No.	Description	Material	Connection	No. of Grooves	Dimensions	Product Weight	Weight Limit
AAA285	Foot Pyramid	Aluminum	Male, M10 Thread	One (1)	24 mm Height; 51 mm / 2 in A-P	67 g / 2.4 oz	136 kg / 300 lb

AAA Mounting Plate



Model No.	Description	Material	Outer Diameter	Connection	Product Height	Product Weight	Weight Limit
AAASMP (Also on page 32)	Mounting Plate***	Aluminum	6.9 cm / 2.7 in	Four-Hole, M18 Thread	17 mm / 0.68 in	118 g / 4.2 oz	205 kg / 450 lb

Made in USA

*Includes set screws. ***Includes expulsion valve insert and fabrication components.

AAA Pylons



Model No.	Description	Adapter Material	Connection	Diameter	Length	Product Weight	Weight Limit
AAA200	Aluminum Pylon Bonded to Female Adapter*	Aluminum	Female	30 mm	420 mm / 16.5 in	324 g / 11.4 oz	160 kg / 350 lb
AAA202	Aluminum Pylon Bonded to Male Adapter	Aluminum	Male	30 mm	420 mm / 16.5 in	329 g / 11.6 oz	160 kg / 350 lb
AAA135	Variable Height Adapter*	Aluminum	Female	30 mm	178 mm / 7.0 in	190 g / 6.7 oz	160 kg / 350 lb
AAA201	Pylon	Aluminum	N/A	30 mm	428 mm / 16.8 in	308 g / 10.9 oz	160 kg / 350 lb

AAAHDTi Heavy-Duty Adapters



Model No.	Description	Material	Connection	Hole Inner Diameter	Product Weight	Weight Limit
AAAHDTi210	4-Hole Pyramid Adapter**/**	Titanium	Male, Four-Hole	N/A	100 g / 3.5 oz	205 kg / 450 lb
AAAHDTi217	Splined 4-Hole Rotatable Adapter**/**	Titanium	Male, Four-Hole	N/A	128 g / 4.5 oz	205 kg / 450 lb
AAAHDTi218	Splined 4-Hole Rotatable Adapter**/**	Titanium	Female, Four-Hole	N/A	138 g / 4.9 oz	205 kg / 450 lb



Model No.	Description	Height	Material	Connection	Product Weight	Weight Limit
AAAHDTi225	Adjustable Height Clamp Adapter**/**	50 mm / 2.0 in	Titanium	Female	102 g / 3.6 oz	205 kg / 450 lb
AAAHDTi221	Double-Ended Adapter*	35 mm / 1.38 in	Titanium	Female	118 g / 4.2 oz	205 kg / 450 lb



Model No.	Description	Adapter Material	Connection	Diameter	Length	Product Weight	Weight Limit
AAAHDTi200	Bonded Pylon 16 Inch*	Titanium/Composite	Female	30 mm	428 mm / 16.5 in	328 g / 11.6 oz	205 kg / 450 lb

Made in USA

*Includes set screws. **Includes mounting screws. ***Includes clamp screw.

The Do's and Don'ts of AAA Application/Use

Manufactured with shot peened aluminum for improved durability and strength.

Do

- ✓ Perform an annual check for signs of corrosion and verify fastener torque
- ✓ Follow correct tightening sequence
- ✓ Apply tightening torque before the recommended Loctite 242 cures
- ✓ Tighten ALL set screws to the specified torque value
- ✓ Apply fastener tightening torque slowly and methodically
- ✓ Tighten the clamp screw first, before the four mounting screws on the rotatable flange
- ✓ Use the correct and properly calibrated torque wrench
- ✓ Ensure the mating components are clean and free of foreign objects
- ✓ Seal the prosthesis if the patient's activities may subject the prosthesis to immersion
- ✓ Use only fasteners provided by Trulife and that are specified for a particular adapter
- ✓ Instruct patient to not make adjustments or alignment changes

Don't

- ✗ Assemble the adapter to a component with incompatible geometry
- ✗ Exceed the recommended fastener tightening torque range
- ✗ Use stainless steel fasteners with AAA components
- ✗ Mount any aluminum component directly against a carbon fiber component
- ✗ Use a torque wrench that has been misused or abused
- ✗ Use components with a male pyramid stud component constructed of softer materials such as aluminum
- ✗ Allow fluids to accumulate and dwell inside a prosthetic assembly
- ✗ Expose adapters to corrosive fluids: water, salt water, chlorinated water, ammonia, acids
- ✗ Exceed the load rating of the device, i.e. body weight plus additional loads that the patient might lift, push or carry
- ✗ Subject the adapters to severe impact

"I have been designing, testing, and re-designing various modular adapters, prosthetic foot components and prosthetic knee components since 2002. All new designs and newly re-designed components were thoroughly tested and pushed to the limit so as to learn the amount of punishment these devices can withstand. Good design practices coupled with the application of well-established manufacturing processes allow us to offer our AAA line of aluminum modular adapters with a higher weight limit. They meet or even exceed the strength and durability of legacy titanium and stainless steel adapters."

— Jay Humphries, Trulife Engineer





Green Dot Total Contact Suction Socket Valve

- Reliable seal
- Lightweight design

Indications: Transfemoral amputees who use thermoformed sockets

Selection

Model No.	Description
P12-310-1000	Green Dot Total Contact Suction Socket Valve, Plastic, Manual Expulsion
T15-600-0000	Valve Key for Green Dot Valves



Green Dot SFS Valve

- Lightweight, replaceable valve housing
- Reliable seal
- Lightweight design

Indications: Transfemoral amputees who use thermoformed sockets

Selection

Model No.	Description
P12-340-1000	Green Dot SFS Valve, Plastic, Manual Expulsion
T15-600-0000	Valve Key for Green Dot Valves



Green Dot Total Contact Suction Valve

- Industry standard in reliable suction
- Lightweight design

Indications: Transfemoral amputees who use lamination sockets

Selection

Model No.	Description
P12-320-1000	Green Dot Total Contact Suction Valve, Stainless Steel, Manual Expulsion
T15-600-0000	Valve Key for Green Dot Valves

Specifications

(All Green Dot Valves)

Distal End of Valve to Top of Threads	10.8 mm / 0.4 in
Diameter at Valve Base	22 mm / 0.9 in
Warranty	2 years
Includes	Valve Key, Valve Plug, Flat Washer, Screw
Made in USA	



Below Knee Valve

- Self expulsion valve
- Installed at the distal end of socket
- For use with suction suspension

Indications: Transtibial amputees

Selection

Model No.	Description
P36110	Below Knee Valve

Specifications

Minimum Distal Socket Thickness	19 mm / 0.8 in
Warranty	2 years
Made in USA	



Specifications

Product Weight	
SEC201, 210:	246 g / 8.6 oz (size 26)
SEC202, 211:	348 g / 12.2 oz (size 26)
SEC220, 223:	94 g / 3.3 oz (size 15)
Product Height	
SEC201, 210:	26 cm / 10.3 in
SEC202, 211:	39 cm / 15.5 in
SEC220, 223:	12-30 cm / 4.8-12 in (varies with foot size)
Warranty	2 years
Made in USA	

Endoskeletal Cosmesis

- Universal cosmesis shape for temporary or permanent application
- Made of durable urethane for quick, easy finishing
- Easy access for alignment changes
- Please have side and foot size available when ordering

Indications: Transtibial amputations; for use with the following feet: Lightfoot with Pyramid, Natural with Pyramid, SACH with Pyramid or Child's Play Energy

Selection

Model No.	Description	Foot Size
SEC201	Endoskeletal Cosmesis, Light	22-26 cm
SEC210	Endoskeletal Cosmesis, Dark	22-26 cm
SEC202	Endoskeletal Cosmesis, Light	26-29 cm
SEC211	Endoskeletal Cosmesis, Dark	26-29 cm
SEC220	Child's Play Endoskeletal Cosmesis, Light	13-21 cm
SEC223	Child's Play Endoskeletal Cosmesis, Dark	13-21 cm



Specifications

Product Weight	
SAB310:	426 g / 15.0 oz
SAB320:	369 g / 13.0 oz
Product Height	
SAB310:	12.4 cm / 4.9 in
SAB320:	8.6 cm / 3.4 in
Max. Clearance (including Foot)	15.5 cm / 6.1 in
Core Diameter	5.1 cm / 2.0 in
Largest Width	11.4 cm / 4.5 in
Warranty	2 years
Made in USA	

Ankle Block

- Lightweight and durable to withstand the forces imposed by dynamic response feet
- High strength, rigid polyurethane foam surrounding a nylon core

Indications:

SAB310: For use with the LightFoot² models SLF195 and SLF198

SAB320: For use with the Natural Foot models SNF160, SNF163, SNF170, SNF173 and SACH Foot models SCH110, SCH113, SCH120, SCH123

Selection

Model No.	Description	Weight Limit
SAB310	Ankle Block, Standard	136 kg / 300 lb
SAB320	Ankle Block, Low Profile	102 kg / 225 lb



Specifications

Product Weight	
SSY300:	42 g / 1.4 oz
SSY301:	14 g / 0.4 oz
SSY302:	20 g / 0.7 oz
SSY303:	28 g / 0.9 oz
Product Height	
SSY300:	18 mm / 0.7 in
SSY 301, 302, 303:	13 mm / 0.5 in
Min. Clearance	(Including Foot)
SSY300:	5 cm / 2 in
SSY301, 302, 303:	4.4 cm / 1.7 in
Warranty	2 years
Made in USA	

Symes Nut

- Provides a broad, solid anterior support surface for laminated sockets
- Fabricated from aluminum alloy
- Abrasive etch finish ensures secure socket adhesion during fabrication

Indications:

SSY300: for use with Lightfoot with Pyramid

SSY301: for use with Child's Play Energy, size 13-15 cm

SSY302: for use with Child's Play Energy, size 16-18 cm

SSY303: for use with Child's Play Energy, size 19-21 cm

Selection

Model No.	Description	Weight Limit
SSY300	Symes Nut	136 kg / 300 lb
SSY301	Child's Play Symes Nut, Foot Size 13-15 cm	31 kg / 69 lb
SSY302	Child's Play Symes Nut, Foot Size 16-18 cm	40 kg / 89 lb
SSY303	Child's Play Symes Nut, Foot Size 19-21 cm	65 kg / 144 lb



AAA Mounting Plate

- Fabricated from aluminum alloy
- Includes expulsion valve assembly and lamination plug

Selection

Model No.	Description	Weight Limit
AAASMP	Mounting Plate	205 kg / 450 lb

Specifications

Product Weight	118 g / 4.2 oz
Product Height	17 mm / 0.68 in
Outer Diameter	6.9 cm / 2.7 in
Center Hole	M18 Threaded
Mounting Pattern	4 x M6 Threaded
Bolt Circle	50.8 mm / 2.0 in
Warranty	2 years
Made in USA	



See How It
Grows with Them!

Build height adjusts from
92-220 mm (3.2-8.7 in)



Contact your distributor today to place an order!



Note: Foot shell is not removable.

Specifications

Weight Limit	65 kg / 144 lb*
Product Sizes	13-21 cm
Toe	13-15 cm: Solid Toe 16-21 cm: Sandal Toe
Foot Shell	Light, Dark
Product Weight	150 g / 0.33 lb (Size 17)
Min. Clearance	
Size 13-15:	4 cm / 1.5 in
Size 16-18:	4.5 cm / 1.8 in
Size 19-21:	4.5 cm / 1.8 in
Heel Rise	
Size 13-15:	6.3 mm / 1/4 in
Size 16-18:	9.5 mm / 3/8 in
Size 19-21:	12.7 mm / 1/2 in
Warranty	
Keel:	2 years
Foot Shell:	1 year
Includes	M8 x 80 mm Foot Bolt Kit (SFB546)
Made in USA	



*For #6 Keel

Child's Play Energy^{K3/K4}

- Pediatric model of the Energy
- Dynamic toe and cushioned heel response
- M8 foot bolt attachment
- Non-removable, sandal-toe foot shell (size 16-21 cm)
- High weight limit of 65 kg / 144 lb

Indications: Medium to high impact level, K3/K4

Selection

Model No.	Description	Size	Weight Limit
SEF132	 Child's Play Energy, Light Foot Shell	13-21 cm	65 kg / 144 lb*
SEF144	 Child's Play Energy, Dark Foot Shell	13-21 cm	65 kg / 144 lb*

Keel Selection Instructions

To determine which keel is appropriate for your patient, check the below table for keel availability by foot size. Please note that sizes 13-15 feet do not have sandal toe foot shells.

Important Note: Choose the next higher keel level if your patient has a long BK limb, regularly carries heavy loads, or is at the upper limit for weight or impact level.

Warning: Choosing a lower strength category than what is suggested based on the above procedure and patient data will void the warranty. If your patient's weight exceeds the limits of the chart please call Trulife Customer Service or your Territory Manager.

Weight Limit	Keel	Foot Length									
		13	14	15	16	17	18	19	20	21	
< 15 kg < 33 lb	1	✓	✓	✓							
16-25 kg 34-55 lb	2	✓	✓	✓	✓	✓	✓				
26-35 kg 56-77 lb	3	✓	✓	✓	✓	✓	✓	✓	✓	✓	
36-45 kg 78-99 lb	4				✓	✓	✓	✓	✓	✓	
46-55 kg 100-121 lb	5							✓	✓	✓	
56-65 kg 122-144 lb	6								✓	✓	✓



AAAK285
Child's Play Energy
Foot Pyramid
(page 36)

AAAK100
Child's Play
Adjustable Height
Clamp Adapter
(page 36)

AAAK135
Child's Play Variable
Height Adapter
(page 36)

SSK610A
Child's Play Knee
with Manual Lock
(page 35)



Child's Play Knee with Manual Lock

- Lightweight, 4-bar, polycentric design
- Friction swing control and extension assist
- Adjustable stability control
- Free motion setting available
- Rotatable knee disarticulation adapter available (SSK610A-DIS)

Indications: AK amputation, pediatric amputee

Selection

Model No.	Description	Weight Limit
SSK610A	Child's Play Knee with Manual Lock	55 kg / 121 lb
SSK610A-DIS	Child's Play Lamination Bracket	

Specifications

Weight Limit	55 kg / 121 lb
Product Weight	310 g / 0.68 lb
Overall Height	12 cm / 4.7 in
Distance to Knee Center	3 cm / 1.2 in
Flexion	140°
Warranty	2 years
Includes	Pyramid Adapter



Trulife Complementary Items



AAAK285
Child's Play
Energy
Foot Pyramid
(page 36)



AAAK221
Child's Play
Double-Ended
Adapter
(page 36)



SSK610A-DIS
Child's Play
Lamination
Bracket



AAAK135
Child's Play
Variable
Height Adapter
(page 36)



SEF132, 144
Child's Play
Energy
(page 34)

Child's Play Modular Adapters

	Model No.	Description	Material	Connection	Diameter	Dimensions	Product Weight	Weight Limit
	AAAK210	Child's Play 4-Hole Pyramid Adapter**	Aluminum	Male, Four-Hole	N/A	N/A	49 g / 1.7 oz	65 kg / 144 lb
	AAAK211	Child's Play 4-Hole Female Adapter*/**	Aluminum	Female, Four-Hole	N/A	N/A	39 g / 1.4 oz	65 kg / 144 lb
	AAAK221	Child's Play Double-Ended Adapter*	Aluminum	Female	22 mm ID	32 mm Height	50 g / 1.8 oz	65 kg / 144 lb
	AAAK100	Child's Play Adjustable Height Clamp Adapter*/***	Aluminum	Female	22 mm ID	70 mm Height	58 g / 2.0 oz	65 kg / 144 lb
	AAAK225	Child's Play Clamp Adapter*/***	Aluminum	Female	22 mm ID	41 mm Height	40 g / 1.4 oz	65 kg / 144 lb
	AAAK135	Child's Play Variable Height Adapter*	Aluminum	Female	22 mm ID	178 mm / 7.0 in Length	87 g / 3.1 oz	65 kg / 144 lb

Child's Play Energy Foot Adapter

	Model No.	Description	Material	Connection	No. of Grooves	Length	Product Weight	Weight Limit
	AAAK285	Child's Play Energy Foot Pyramid	Aluminum	Male M8 Thread	One (1)	37 mm / 1.45 in	33 g / 1.2 oz	65 kg / 144 lb

Child's Play Mounting Plate

	Model No.	Description	Material	Diameter	Connection	Height	Product Weight	Weight Limit
	AAAKSMP	Child's Play Mounting Plate**/****	Aluminum	OD 5.8 cm / 2.3 in; ID 31.75 mm / 1.25 in	Four-Hole	14 mm / 0.55 in	56 g / 2.0 oz	65 kg / 144 lb

All Child's Play Modular Adapters are made in USA and come with a 2 year warranty.
*Includes set screws. **Includes mounting screws. ***Includes clamp screw.****Includes fabrication components.



Specifications

Product Weight	94 g / 3.3 oz (Size 15)
Calf Circumference	20 cm / 10.2 in
Height	12-30 cm / 4.8-12.1 in (Height depends on foot size)
Fits Foot Size	13-21 cm
Warranty	2 years
Made in USA	

Child's Play Endoskeletal Cosmesis

- Universal cosmesis shape for temporary or permanent application
- Made of durable urethane for quick, easy finishing
- Easy access for alignment changes
- Please have side and foot size available when ordering

Indications: Transtibial amputations; for use with Child's Play Energy

Selection

Model No.	Description	Foot Size
SEC220	Child's Play Endoskeletal Cosmesis, Light	13-21 cm
SEC223	Child's Play Endoskeletal Cosmesis, Dark	13-21 cm



Specifications

Diameter (OD)	9.2 cm / 3.6 in (OD)
Diameter (Top)	7.1 cm / 2.8 in
Height	3.2 cm / 1.3 in
Product Weight	93 g / 3.2 oz
Warranty	2 years
Made in USA	

Child's Play Laminating Block

- High strength, rigid polyurethane foam around a nylon core
- 4-hole connection
- Easily shaped during fabrication

Indications: For use with Child's Play Energy

Selection

Model No.	Description	Weight Limit
SLB240	Child's Play Laminating Block	65 kg / 144 lb



Specifications

Fits Foot Size	
Size 13-15:	SFS240, 241
Size 16-18:	SFS242, 243
Size 19-21:	SFS244, 245
Warranty	2 years
Made in USA	

Child's Play Foot Spacer

- Provides versatility during setup and fabrication
- Designed of lightweight nylon
- For temporary or permanent use

Indications:

SFS240, 241 – Ideal for use with the Child's Play Energy, size 13-15 cm

SFS242, 243 – Ideal for use with the Child's Play Energy, size 16-18 cm

SFS244, 245 – Ideal for use with the Child's Play Energy, size 19-21 cm

Selection

Model No.	Description	Size	Product Wt	Weight Limit
SFS240	Child's Play Foot Spacer	0.6 cm / 0.25 in	6.0 g / 0.2 oz	31 kg / 69 lb
SFS241	Child's Play Foot Spacer	2.5 cm / 1.0 in	20.0 g / 0.7 oz	31 kg / 69 lb
SFS242	Child's Play Foot Spacer	0.6 cm / 0.25 in	9.0 g / 0.3 oz	41 kg / 89 lb
SFS243	Child's Play Foot Spacer	2.5 cm / 1.0 in	28.0 g / 0.9 oz	41 kg / 89 lb
SFS244	Child's Play Foot Spacer	0.6 cm / 0.25 in	11.0 g / 0.3 oz	65 kg / 144 lb
SFS245	Child's Play Foot Spacer	3.0 cm / 1.2 in	45.0 g / 1.5 oz	65 kg / 144 lb



Specifications

Height	8.6 cm / 3.4 in
Max Clearance	(Including Foot)
SAB314:	9.4 cm / 3.7 in
SAB315:	10.4 cm / 4.1 in
SAB316:	11.2 cm / 4.4 in
Core Diameter	
SAB314:	3.0 cm / 1.2 in
SAB315:	3.5 cm / 1.4 in
SAB316:	4.1 cm / 1.6 in
Largest Width	7.9 cm / 3.1 in
Warranty	2 years
Made in USA	

Child's Play Energy Ankle Block

- Lightweight, durable ankle block
- High strength, rigid polyurethane foam surrounding a nylon core

Indications:

SAB314 – For use with the Child's Play Energy, size 13-15 cm

SAB315 – For use with the Child's Play Energy, size 16-18 cm

SAB316 – For use with the Child's Play Energy, size 19-21 cm

Selection

Model No.	Description	Foot Size	Product Weight	Weight Limit
SAB314	Child's Play Energy Ankle Block	13-15 cm	123 g / 4.3 oz	35 kg / 77 lb
SAB315	Child's Play Energy Ankle Block	16-18 cm	146 g / 5.1 oz	45 kg / 99 lb
SAB316	Child's Play Energy Ankle Block	19-21 cm	179 g / 6.3 oz	65 kg / 144 lb



Specifications

Min Clearance	(Including Foot)
SLC301:	5.6 cm / 2.2 in
SLC302:	5.8 cm / 2.3 in
SLC303:	6.0 cm / 2.4 in
Max Clearance	(Including Foot)
SLC301:	9.4 cm / 3.7 in
SLC302:	10.4 cm / 4.1 in
SLC303:	11.2 cm / 4.4 in
Warranty	2 years
Made in USA	

Child's Play Laminating Core

- High strength, low profile alternative to an ankle block
- Requires minimal keel to socket clearance
- Ribbed nylon for secure adhesion in the lamination process

Indications: For laminated sockets, maximum weight of 65 kg / 144 lb; for use with Child's Play Energy

Selection

Model No.	Description	Foot Size	Product Weight	Weight Limit
SLC301	Child's Play Laminating Core	13-15 cm	28 g / 0.9 oz	31 kg / 69 lb
SLC302	Child's Play Laminating Core	16-18 cm	50 g / 1.7 oz	40 kg / 89 lb
SLC303	Child's Play Laminating Core	19-21 cm	79 g / 2.7 oz	65 kg / 144 lb



Specifications

Min Clearance	(Including Foot)
	4.0 cm / 1.6 in
Warranty	2 years
Made in USA	

Child's Play Symes Nut

- Provides a broad, solid anterior support surface
- Fabricated from aluminum alloy
- Abrasive etch finish ensures secure socket adhesion during fabrication

Indications: For use with Child's Play Energy

Selection

Model No.	Description	Foot Size	Product Weight	Weight Limit
SSY301	Child's Play Symes Nut	13-15 cm	14 g / 0.4 oz	31 kg / 69 lb
SSY302	Child's Play Symes Nu	16-18 cm	120 g / 0.7 oz	40 kg / 89 lb
SSY303	Child's Play Symes Nut	19-21 cm	28 g / 0.9 oz	65 kg / 144 lb



Warranty

Warranty Specifications

Feet: Zenith, Zenith LP, Triumph	Keel: 3 years Cosmesis: 6 months
Feet: Zumo, Energy, Edge	Keel: 2 years Cosmesis: 6 months
Feet: All Other Models	Keel: 2 years Cosmesis: 1 year
Knees: All Models	2 years
Modular Components: All Models	2 years
Valves: All Models	2 years
Endoskeletal and Exoskeletal Components:	2 years
Repairs and Refurbishes:	90 days

Note: Warranty durations begin the date of installation, repair or refurbish.

Trulife warrants each of its prosthetic devices subject to conditions below, to be free from defects in material and workmanship under normal use, service, and proper installation, for the time period specified below:

If failure of a purchased product occurs during this period because of a defect in material or workmanship, upon satisfaction of the conditions set forth below, Trulife will replace, repair, or refund the product at no charge to the original retail purchaser.

Your sole and exclusive remedy, as the original retail purchaser, in the event of a defect is found, is expressly limited to replacement or repair of the product, although Trulife may elect to refund, not to exceed the purchase price, rather than replace or repair the product. Replacement products are warranted for only the remainder of the original warranty period. Warranty is nontransferable and may only be exercised by the original purchaser.

The limited warranty contained herein is in lieu of all other written or expressed warranties. Any implied warranty, including the implied warranties of merchantability or fitness for a particular purpose, is limited in length to the duration of this limited warranty. Some states do not allow limitation on how long an implied warranty lasts, so the above limitation may not apply to you.

Trulife's sole responsibility is to replace, repair, or refund as stated herein, and Trulife shall not be liable for any special, indirect, or consequential damages including loss of time, inconvenience, loss of the use of the product, or commercial losses. Some states do not allow the exclusion or limitation of incidental or consequential damages, so the above limitation or exclusion may not apply to you.

This warranty gives you specific legal rights, and you may also have other rights which vary from state to state.

The application guidelines for this Trulife product are for the use of and by certified, qualified practitioner only. Patients are not to attempt to apply or adjust the item unless expressly instructed to do so by the practitioner responsible for the prescription and/or initial fitting of the device. All patient questions should be referred to the practitioner and not to the manufacturer. The manufacturer warrants only that the enclosed product has been inspected for quality and can be effective for certain indications, but final decisions and ongoing monitoring must be made by the prosthetic professional(s) prescribing and/or fitting the device to determine its effectiveness for an individual patient. Patient compliance is an integral part of the entire protocol and must be adhered to in order to avoid potential problems and to maximize the effectiveness of the prescribed product.

As a condition of the sale of any Trulife product, this prosthesis is restricted to a "Single Patient Use Only" by the originally fitted patient in order to protect the care provider and the patient against potentially adverse consequences of infectious disease transmission, material instability in adapting to the configuration of the original user and/or decrease in effectivity. Any express or implied warranties are voided if the product is reused or fitted to another patient. Additionally, a license of right to use under any relevant patents pertaining to the product is terminated with the cessation of use by the original patient. As with all Trulife products, this product must be prescribed and applied by a qualified practitioner to determine it meets the needs of the particular patient and accomplishes the desired results.



www.trulife.com

 [/trulifegroup](https://www.facebook.com/trulifegroup)  [/company/trulife](https://www.linkedin.com/company/trulife)  [@TrulifeGroup](https://twitter.com/TrulifeGroup)